

## Flush-type connector - SACC-CI-M12FS-8CON-L90 SH SCO - 1437009

Please be informed that the data shown in this PDF Document is generated from our Online Catalog. Please find the complete data in the user's documentation. Our General Terms of Use for Downloads are valid (<http://phoenixcontact.com/download>)

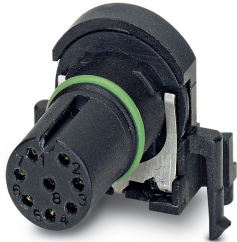

Sensor/actuator flush-type connector, socket, 8-pos., A-coded, shielded, with angled solder connection, only contact insert

### Your advantages

- ✓ Reduced mounting costs thanks to two-piece device connector
- ✓ All common pin assignments and codings available
- ✓ Easy device integration thanks to mechanical port screw connections with threaded attachment, press-in contour or direct integration in the front plate
- ✓ Additional gasket for the device when not plugged in



### Key Commercial Data

Packing unit	1 pc
Minimum order quantity	20 pc
GTIN	 4 046356 438575
GTIN	4046356438575
Weight per Piece (excluding packing)	0.250 g
Custom tariff number	85366990
Country of origin	Germany

### Technical data

#### Ambient conditions

Ambient temperature (operation)	-25 °C ... 85 °C (Plug / socket)
	-40 °C ... 85 °C (without mechanical actuation)
	-25 °C ... 85 °C (Plug / socket)
Degree of protection	IP67

# Flush-type connector - SACC-CI-M12FS-8CON-L90 SH SCO - 1437009

## Technical data

### General

Note	The electrical and mechanical data specified assume that the connector pair is correctly locked and mounted. If the connector is unlocked and if there is a danger of contamination, the connector must be sealed using a protective cap > IP54. Influences arising from litz wires, cables or PCB assembly must also be taken into consideration.
Rated current at 40°C	2 A
Rated voltage	30 V
Rated surge voltage	0.8 kV
Number of positions	8
Insulation resistance	≥ 100 MΩ
Coding	A - standard
Standards/regulations	M12 connector IEC 61076-2-101
Status display	No
Overvoltage category	II
Degree of pollution	3
Connection method	Solder pins
Insertion/withdrawal cycles	> 100
Torque	3 Nm ... 4 Nm (Installation-side)
Mounting type	PCB mounting

### Material

Flammability rating according to UL 94	V0
Contact material	CuZn
Contact surface material	Au
Contact carrier material	PA 6.6
Sealing material	FKM / EPDM

### Cable

Standards/specifications	M12 connector IEC 61076-2-101
--------------------------	-------------------------------

### Standards and Regulations

Standards/specifications	M12 connector IEC 61076-2-101
Flammability rating according to UL 94	V0

### Environmental Product Compliance

REACH SVHC	Lead 7439-92-1
China RoHS	Environmentally Friendly Use Period = 50 years
	For details about hazardous substances go to tab "Downloads", Category "Manufacturer's declaration"

## Drawings

# Flush-type connector - SACC-CI-M12FS-8CON-L90 SH SCO - 1437009

Schematic diagram

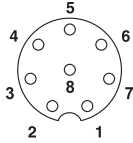

Pin assignment M12 socket, 8-pos., A-coded, view female side

Drilling diagram

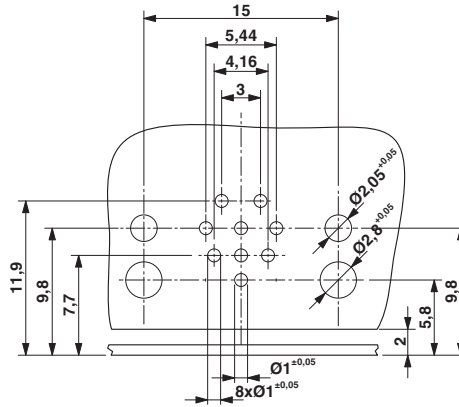

Drilling diagram only valid in connection with the SACC-M12-SCO NUT L90 housing (order no. 1432460)

Dimensional drawing

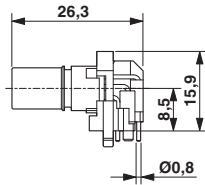

M12 flush-type connector, socket, contact carrier, side view

Dimensional drawing

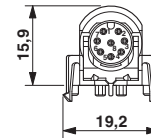

M12 flush-type connector, socket, contact carrier, front view

Dimensional drawing

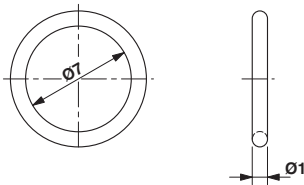

Optionally with O-ring (green) for tight seal when plugged in.  
 - the axial mating force of 80 N per connector may not be exceeded when using with assembled O-ring!  
 - Avoid radial forces!

Dimensional drawing

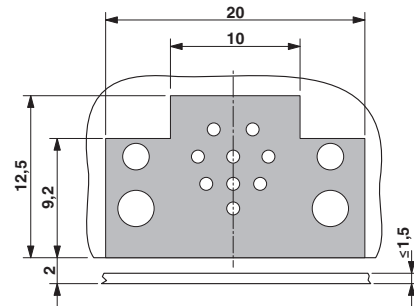

Locked area on the PCB

# Flush-type connector - SACC-CI-M12FS-8CON-L90 SH SCO - 1437009

## Classifications

### eCl@ss

eCl@ss 10.0.1	27440102
eCl@ss 11.0	27440102
eCl@ss 4.0	27260700
eCl@ss 4.1	27260700
eCl@ss 5.0	27260700
eCl@ss 5.1	27260700
eCl@ss 6.0	27279200
eCl@ss 7.0	27440103
eCl@ss 9.0	27440102

### ETIM

ETIM 3.0	EC002061
ETIM 4.0	EC002061
ETIM 6.0	EC002061

### UNSPSC

UNSPSC 6.01	31251501
UNSPSC 7.0901	31251501
UNSPSC 11	31251501
UNSPSC 12.01	31251501
UNSPSC 13.2	39121413
UNSPSC 18.0	39121413
UNSPSC 19.0	39121413
UNSPSC 20.0	39121413
UNSPSC 21.0	39121413

## Approvals

### Approvals

---

Approvals

UL Recognized / EAC

---

Ex Approvals

---

### Approval details

# Flush-type connector - SACC-CI-M12FS-8CON-L90 SH SCO - 1437009

## Approvals

UL Recognized		<a href="http://database.ul.com/cgi-bin/XYV/template/LISEXT/1FRAME/index.htm">http://database.ul.com/cgi-bin/XYV/template/LISEXT/1FRAME/index.htm</a>	FILE E 118976
Nominal voltage UN		30 V	
Nominal current IN		2 A	
mm <sup>2</sup> /AWG/kcmil		24	

EAC		B.01687
-----	--	---------

## Accessories

### Accessories

#### Panel mounting base

#### Housing screw connection - SACC-M12-SCO NUT - 1552243



M12 SPEEDCON housing screw connection for M12 female inserts, with O-ring, for all SPEEDCON-capable THR and wave soldering contact carriers

#### Housing screw connection - SACC-DSIV-M12-NUT - 1416144



Housing screw connection with M12 standard thread, with O-ring, for the two-piece straight M12 THR contact carrier and for the two-piece angled M12 contact carrier

#### Housing screw connection - SACC-M12-SCO NUT L 90 - 1432460



M12-SPEEDCON housing screw connection for M12 female inserts, with flat gasket, for all Speedcon-compatible THR and wave soldering contact carriers

## Flush-type connector - SACC-CI-M12FS-8CON-L90 SH SCO - 1437009

### Accessories

Housing screw connection - SACC-BP-F-M12/M15-6-THR - 1414004



Housing screw connection, Socket, M12, Rear mounting, M15 x 1

---

Housing screw connection - SACC-BP-F-M12/M15-7-THR - 1414003



Housing screw connection, Socket, M12, Rear mounting, M15 x 1

---

Housing screw connection - SACC-BP-F-M12/M15-6-THR SCO - 1414020



Housing screw connection, Socket, M12-SPEEDCON, Rear mounting, M15 x 1

---

Housing screw connection - SACC-BP-F-M12/M15-7-THR SCO - 1414005



Housing screw connection, Socket, M12-SPEEDCON, Rear mounting, M15 x 1

---

Housing screw connection - SACC-M12 NUT PRESS - 1437889



Housing screw connection for two-piece M12 connectors for the reflow soldering process.

---

## Flush-type connector - SACC-CI-M12FS-8CON-L90 SH SCO - 1437009

### Accessories

Housing screw connection - SACC-BP-F-M12-THR PP - 1027662



Housing screw connection, Socket, M12-Push-Pull, Rear mounting, M16, THR- und Wellenlötkontakte

---

Housing screw connection - SACC-FP-F-M12-THR PP - 1027678



Housing screw connection, Socket, M12-Push-Pull, Front mounting, M14 x 1, THR- und Wellenlötkontakte

---

### Plug for cable screw gland

Screw plug - PROT-M12 - 1680539



An M12 screw plug for the unoccupied M12 sockets of the sensor/actuator cable, boxes and flush-type connectors

---

Screw plug - PROT-M12 SH - 1503302



An M12 screw plug for the unoccupied M12 sockets of the shielded sensor/actuator cable, boxes and flush-type connectors

---

Screw plug - PROT-M12 FB - 1555538



M12 high-grade steel screw plug, for unoccupied M12 sockets of the sensor/actuator cables, boxes and flush-type connectors for the food industry

---

